

# 电脑款厚料机系列电控使用说明书

## Computerized heavy duty machine electric control box manual

### 安全事项

- 在使用本产品之前，请先阅读《产品说明书》及所搭配的缝纫机机械说明书。
  - 本产品必须由接受过专业培训的人员来安装或操作。
  - 请尽量远离电弧焊接设备，以免产生的电磁波干扰本控制器而发生误动作。
  - 请不要在室温 45°以上或者 0°以下的场所使用。
  - 请不要在湿度 30%以下或者 95%以上或者有露水和酸雾的场所使用。
  - 安装控制箱及其他部件时，请先关闭电源并拔掉电源插头。
  - 为防止干扰或漏电事故，请做好接地工程，电源线的接地线必须牢固的与大地有效连接。
  - 所有维修用的零部件，须由本公司提供或认可，方可使用。
  - 在进行任何保养维修动作前，必须关闭电源并拔掉电源插头。控制箱里有高压危险，必须关闭电源五分钟后方可打开控制箱。
- Safety Precautions
  - Before using this product, please read the User's Guide and the manual of the machine attached with it.
  - This product must be installed or operated by professionally trained personnel.
  - Please keep away from the arc welding equipment to avoid the electromagnetic wave from interfering with the controller.
  - Please do not use it at room temperature above 45° or below 0°.
  - Please do not use it in places with humidity below 30% or above 95% or where there is dew and acid mist.
  - When installing the control box and other parts, turn off the power and unplug the power plug.
  - To prevent interference or electric leakage accidents, make a good grounding work. The grounding wire of the power cord must be firmly connected to the earth.
  - All parts for maintenance must be supplied or approved by the Company before they can be used.
  - The power must be turned off and the plug unplugged before any maintenance action is performed. There is a high-voltage danger in the control box. You must shut down the power for 5 minutes before opening the control box.

## 1 产品安装 Product Installation

### 1.1 产品规格 product specification

电源电压 Voltage	AC 220±20% V
电源频率 Supply frequency	50Hz/60Hz
最大输出功率 maximum output power	750W

### 1.2 接口插头的连接 The connection of interface plug

将脚踏板及机头的各连接插头安插到控制器后面对应的插座上，各插座名称如图 1-2-2 所示。连接好，请检查插头是否插牢。

Insert the connecting plugs of the foot pedal and the head of the machine into the corresponding socket at the back of the controller. Each socket names are shown in figure 1-2-2. Please check whether the plug is inserted.



图 1-2-1 控制器图 (controller drawing)

- ①脚踏板&升级插座 Socket of foot pedal and updating;  
 ②电磁铁、LED 灯、机头按键插座。Socket of Electromagnet, LED Lamp and machine head

脚踏板&升级接口			机头电磁铁接口		
接口	定义	备注	接口	定义	备注
1	GND	5V数字地	1	EM-JX	剪线电磁铁
2	-	-	2	EM-QX	钳线电磁铁
3	VCC	+5V	3	EM-TYJ	抬压脚电磁铁
4	RX	UART通信接收	4	DCND	-
5	TX	UART通信发送	5	DF-IN	倒缝信号
6	Pedal	脚踏板模拟信号	6	EM-DF	倒缝电磁铁
			7	BZ-IN	补针信号
			8	VDD	电磁铁电源
			9	VDD	+32V
			10	VDD	+32V
			11	L5V	LED机头灯+
			12	DCND	-
			13	VDD	+32V
			14	DCND	-

图 1-2-2 控制器接口定义 (controller connection plug definition)

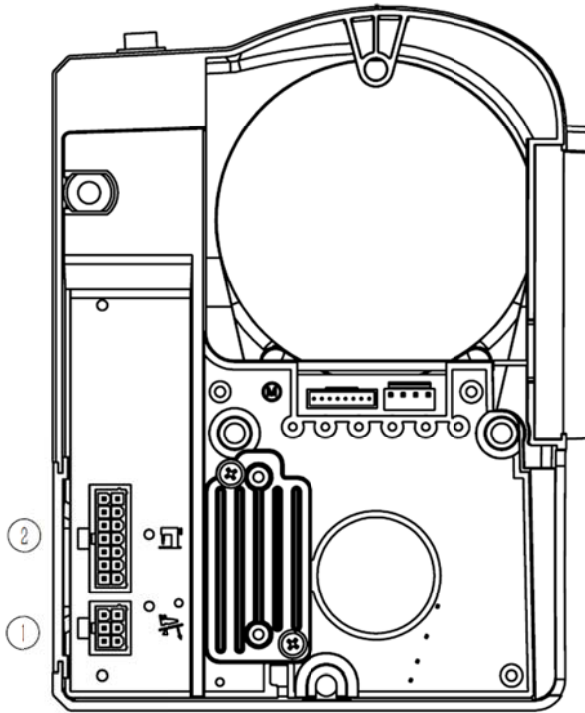
注：使用正常力量插不进去时，请检查插头与插座是否匹配，插入方向或针的方向是否正确！

If it cannot be inserted normally, please check the plug and socket match or not, the direction of the insertion or the direction of the needle is correct or not.

### 1.3 接线与接地

必须要做好系统的接地工程，请合格的电气工程人员予以施工。产品通电及投入使用前，必须确保电源插座 AC 输入端已安全可靠的接地。系统的接地线为黄绿线，该地线请务必可靠连接至电网安全保护接地上，以保证安全使用，并可防止出现异常情况。

The grounding of the system must be completed, and qualified electrical engineers shall be required to construct. Before the product is energized and put into use, it is necessary to ensure that the AC input already connected the grounding. The standard grounding line is the yellow and green line. The ground wire must be reliably connected to the grid safely to protect grounding and ensure safely using and to prevent abnormal conditions.

注：所有电源线、信号线、接地线等接线时不要被其它物体压到或过度扭曲，以确保使用安全。

All power wires, signal wires, ground wires and other wiring should not be pressed or distorted by other objects to ensure safety.

## 2 操作面板使用说明 Operation panel introductions

### 2.1 操作面板的显示说明 display introduction

根据系统工作状态，操作面板的数码管将显示当前的缝纫状态（包含停针位指示）。操作面板外观如下所示。According to the working status of the system, the digital tube of the operation panel will display the current sewing status (including the needle position indicate).The appearance of the operation panel is shown as below.









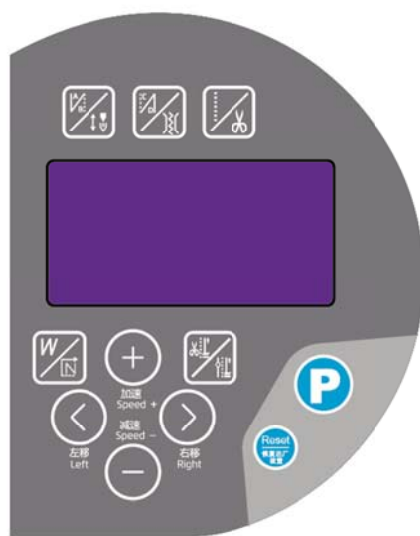

图 2-1 操作面板外观界面 appearance of operation panel

### 2.2 按键各按键功能说明 function declaration of each key







序号	外观	名称	功能描述
1		进入参数区功能键 parameter mode	参数功能进入键 enter the parameter function
2		参数加键（速度加） Up key(speed up)	在进入参数功能参数号/值加，初始待机下速度加 Enter this mode, adjust this key, increase speed









3		参数减键（速度减） Down key(speed down)	在进入参数功能参数号/值加，初始待机下速度加 Enter this mode, adjust this key, decrease speed
4		左移键 key left	参数设定中，向左选择参数范围 turn to left to choose parameter
5		右移键 key right	参数设定中，向右选择参数范围 turn to right to choose parameter
6		恢复出厂设置键 reset key	长按 3S 后恢复出厂设置 press 3 seconds, then back to factory setting
7		前加固缝键/停针位选择键 Start tacking/needle position Section key	<p>1. 前固缝选择键，每短按动一次，在设置前固缝、前双固缝、关闭之间循环选择，对应液晶屏图标点亮。选择对应的键可设置 A、B 段的针数。</p> <p>The start tacking key is selected for each short press, the cyclical selection is between the front tacking, the front double tacking and the closing, and the corresponding LCD screen is lit. Select the corresponding key to set the number of needles of A and B.</p> <p>2. 长按进入上/下停针位选择键</p> <p>Press long time to enter needle position function</p>
8		后加固缝键/夹线 Back tacking/ thread clamp	<p>1. 后固缝选择键，每短按动一次，在设置后固缝、后双固缝、关闭之间循环选择，对应液晶屏图标点亮。选择对应的键可设置 C、D 段的针数。</p> <p>The back tacking key is selected for each short press, the cyclical selection is between the front tacking, the front double tacking and the closing, and the corresponding LCD screen is lit. Select the corresponding key to set the number of needles of C and D.</p> <p>2.短按此键，液晶屏夹线图标亮，夹线功能开启，再短按一次，夹线功能关闭；</p> <p>Press this key for short time,ico become lit, so thread clamp is working now, press again, the turn this function</p>

9		自由缝键/ 剪线键 Free sewing/trimmer	<p>1、短按此键，液晶屏自由缝图标亮，选择自由缝模式；          press for short time, icon become lit, choose free sewing function.</p> <p>2、长按此键，液晶屏剪线图标亮，自动剪线功能开启，再长按此键，自动剪线功能关闭。          Press for long time, icon become lit, trimmer function turn on, press again, trimmer function turn off.</p>
10		W 缝键/ 多段缝键 W sewing/ Multi-segment Tacking	<p>1、短按此键，液晶屏 图标亮，表示当前是 W 缝模式。选择对应的键可设置 A、B、D 参数；Press this key for short time, icon is lit, so now is W sewing mode, choose the corresponding key to set A,B,C,D</p> <p>2、长按此键，液晶屏 图标亮，表示当前是多段缝模式。选择对应的键可设置多段缝总段数、每段针数。          Press the key for long time, icon is lit, means now is Several Segment Tacking mode, choose corresponding key to set all steps, and all stitches of each step.</p>
11		抬压脚键 press foot lift key	<p>1、短按此键，用于选择或取消剪线后抬压脚功能，选择时液晶屏幕下方会显示剪线后抬压脚状态标识；press this key for short time, choose or cancel this function. If choose this function, then will show press foot lift after trimmer</p> <p>2、长按此键，用于选择或取消中途抬压脚功能，选择时液晶屏幕下方会显示中途抬压脚状态标识；          Press this key for long time, choose or cancel this function, if choose, will show press foot lift on halfway</p> <p>3、P 键+抬压脚键两个按键同时按进入监控参数。Press P+press foot lift key at same time, enter technician parameter mode</p>

### 3 参数调节 Parameter adjustment

#### 3.1 进入操作员参数模式及保存 enter parameter mode and saving

空闲模式下，长按  键进入操作员参数模式。按  或  移动光标，相应位数值闪烁，再按  或  修改该位数值，按  键，保存参数。如果参数未修改，按  键退出参数模式；如果参数已经修改，第一次按键保存参数，第二次按  键退出参数模式。



Press , enter parameter mode, then press  or  to move the lit, corresponding number flashing, then press  or  to modify this value, press , save the parameter. If not modified, press  to log out parameter mode, if already modify, firstly save parameter, then press  to log out parameter mode.



### 3.2 进入技术员参数模式及保存 **Enter technician parameter mode and save it**

按住  键开机进入技术员参数模式。参数调节方式同操作员参数调节方式。

Press  and turn on the machine to enter technician parameter mode. The methods is same as parameter mode.

### 3.3 速度调节 **Speed adjustment**

在空闲模式下，按上键  下键  调速度。向上调快，向下调慢，每按一次调整数值 50，可以连续按。



Press  and  to adjust the speed. For up, to adjust fast, for down, to adjust slow. each adjustment value is 50.



### 3.4 恢复出厂设置



长按  恢复出厂设置，作为恢复出厂设置的快捷方式。



Press the  for a long time, back to the factory setting.

### 3.5 进入监控模式 **enter monitoring system**

在空闲按  +  键进入，按上下键调整监控参数项，按 P 键退出。（若为 24、25、26、28 项，长按 P 键保存当前监控值为对应参数，若保存成功，显示 OK，短按 P 键退出监控模式）

Press  +  to enter this mode, press up and down key to adjust this parameter, press P, then can log out. (if it is 24、25、26、28, then press P to save this monitoring value as the corresponding parameter, if save successfully, show OK, press P for short time to log out this mode. )

注：上停针位置设置：进入监控参数项 24，将手轮调整至上停针（参数会随着手轮位置而变化），长按  键保存参数（保存后，下针位会自动进行相应调整），按  退出监控模式。

PS: Needle position setting, enter monitoring mode number 24, move the hand wheel to up needle position (the value will be changed with hand wheel position), press  for long time to save it (after save it, down needle position will be adjust automatically), press  to log out this mode.

### 3.6 参数表 Parameters list

#### 3.6.1 操作员参数(长按 P 键进入) technician mode parameter (long press P key to enter)

参数项 Parameter List	参数描述 Description	默认值 Default Value	参数范围 Parameter range	参数项 Parameter List	参数描述 Description	默认值 Default Value	参数范围 Parameter range
P00	起缝速度(r/min) start sewing speed	200	100-800	P22	补针时倒缝关闭阈值 Value of backstitch during half stitch	8	0-9999
P01	自由缝最高转(r/min) Max speed of free sewing	2000	200-2000	P23	脚踏板控速曲线模式 curve mode of pedal 0: 直线 straight 1: 两段斜率 Slope 2: 曲线 curve (平方 square、开方 extraction of a root) 3: S 曲线 S curve	0	0-3
P02	多段缝速度 (r/min) Multi-segment sewing speed	2000	200-2200	P24	踏板剪线位置 Pedal position of trimming	150	0-4095
P03	上下停针选择 Needle position 0: 上停针 up 1: 下停针 down	1	0-1	P25	后固缝针迹补偿 1 Stitch compensation of back tacking 1 (吸合 actuation)	32	1-120
P04	前固缝速(r/min) Start tacking speed	1000	200-2200	P26	后固缝针迹补偿 2 Stitch compensation of back tacking 1 (释放 release)	33	1-120
P05	后固缝速(r/min) Back tacking speed	1000	200-2200	P27	感应抬压脚模式选择 sensor press foot lifter mode selection 0: 关闭 close 1: 打开 open	0	0-1
P06	W 缝速度(r/min) W sewing	1000	200-2200	P28	感应抬压脚保护时间(s) protection time of sensor press foot lifter	5	1-20
P07	慢速起缝速(r/min) Soft start sewing speed	400	100-2000	P29	幂次控速曲线辅助参数 Power Control Curve Auxiliary Parameters 0: 平方 square 1: 开方 extract a root	1	0-1
P08	慢速起缝针数 Soft start sewing stitch	2	1-9	P30	电机低速加力功能开关 switch for Low speed of motor power 0: 正常开关 normal switch 1—31 低速加力过厚能力档位 low speed lever	0	0-31
P09	慢速起缝开关 Soft start sewing switch 0: 关闭 off 1: 打开 on	1	0-1	P31	剪线加力系数 (电机加力) Trimmingr strength coefficient (motor force)	20	10-60
P10	W 缝针迹补偿 1 (吸合) stitch compensation 1	32	1-120	P32	夹线电磁铁全出力时间 thread clamp magnet work time	40	1-200
P11	W 缝针迹补偿 2 (释放) stitch compensation 1(release)	33	1-120	P33	夹线电磁铁每周周期开通时间 thread clamp magnet dredging time	6	1-10

P12	补半针延迟时间(ms) Delay time for half stitch	150	1-180	P34	多段缝运动模式选择 Multi-segment sewing motion mode selection. 0:一键触发功能关 one key start function off 1:一键触发功能开 one key start function off	0	0-1
P13	补一针延迟时间(ms) Delay time for one stitch	180	150-250	P35	夹线开关 Thread clamp switch	1	0-1
P14	补针速度(r/min) Half stitch speed	200	100-500	P36	面线检测结束角度 threads testing ending angle	25	1-360
P15	按键补针模式 mode of half stitch 0: 按时间补针 Half stitch according to time to 1: 补半针 half stitch 2: 补一针 one stitch	0	0-2	P37	夹线电磁铁每周期关闭时间 Thread clamp magnet closing time	4	1-10
P16	预留 reserved	10	1-30	P38	剪线开关 trimmer switch 0: 关闭 off 1: 打开 on	1	0-1
P17	预留 reserved	20	1-90	P39	缝中抬压脚开关 press foot lifter in halfway 0: 关闭 off 1: 打开 on	0	0-1
P18	前固缝针迹补偿 1 Start back tack stitch compensation 1	32	1 - 120	P40	剪线后抬压脚开关 switch of auto press foot lifter after trimming 0: 关闭 off 1: 打开 on	0	0-1
P19	前固缝针迹补偿 2 Start back tack stitch compensation 2	33	1 - 120	P41	计针数计数单位 unit of counter	1	1-50
P20	预留 reserved	345	1-360	P42	计针数总数设定 setting of total counter	9999	1-9999
P21	手动倒缝最高(r/min) max speed of manual reverse sewing	2200	200-2500	P43	计针数模式选择 counter mode 0: 关闭 off 1: 升序循环计数 Ascending cycle count. 2: 降序循环计数 Descending cycle count. 3: 升序计数, 计满报警并停止运行 Ascending accounting to full, alarm and stop running 4: 降序计数, 减为 0 报警并停止运行 Descending accounting to 0, alarm and stop running) 5:升序计数, 计满报警提示, 继续运行 (Ascending accounting to full, remind and keep running) 6: 降序计数, 减为 0 报警提示, 继续运行 (Descending accounting to 0, alarm and keep running) 注: 短按 P 取消报警 (note: press P shortly to cancel alarm)	0	0-6



### 3.6.2 技术员参数表（按住 P 键再开机进入） Technician Parameter list (Press P and switch on to enter)

参数项 Parameter List	参数描述 Description	默认值 Default Value	参数范围 Parameter range	参数项 Parameter List	参数描述 Description	默认值 Default Value	参数范围 Parameter range
P44	轻前踏抬压脚确认延迟时间 0: 关闭 1-300: 根据延迟时间开启 press the pedal forward lightly to confirm delayed time 0: off 1-300:start according to the delayed time	0	0-300	P75	踏板回中位置设定 setting of pedal back to middle position	1650	0-4095
P45	倒缝电磁铁每周期开通时间(ms) starting time of backstitching electromagnet	1	1-10	P76	倒缝电磁铁全出力时间 work time of backstitching electromagnet of (ms)	60	1-200
P46	倒缝电磁铁每周期关闭时间(ms) closing time of backstitching electromagnet	2	1-10	P77	电机方向 motor direction 0: 正转 forward1: 反转 reversal	0	0-1
P47	剪线后反拉 after trimmer and pull back	360	200-360	P78	夹线开始角度 Thread clamp ending angle	182	10-359
P48	倒缝电磁铁保护时间(s) protection time of backstitching electromagnet	10	1-60	P79	夹线结束角度 Thread clamp end angle	280	0-359
P49	剪线速度(r/min)trimmer speed	250	100-500	P80	剪线开始角度 trimming starting angle	7	0-359
P50	抬压脚电磁铁全出力时间 working time of electromagnet of press foot lifter(ms)	250	100-500	P81	剪线加力角度 trimming strength angle	100	0-359
P51	抬压脚电磁铁每周期开通时间(ms) electromagnet of press foot lifter	3	1-10	P82	剪线结束角度 Trimming ending angle	185	0-359
P52	放压脚延迟时间 (ms)delaying time of down presser foot lift	2	0-500	P83	踏板抬压脚确认时间 (ms) Pedal presser foot confirmation time.	150	1-500
P53	抬压脚位置抬压脚功能选择 0: 不抬 No 1: 抬 Yes	0	0-1	P84	安全开关报警确认时间 (ms) The confirmation time of Safety switch alarm	300	1-500
P54	抬压脚每周期关闭时间 (ms)closing time of presser foot lift for each period	5	4-10	P85	安全开关报警恢复时间 (ms) The recovery time of Safety switch alarm	50	1-200
P55	预留 reserved	0	0-1	P86	两段斜率转折点速度 (r/min) speed of two slopes at a turning point.	1500	0-4000

P56	上电自动找上针位 connect power and finding needle position automatically 0: 不找 No 1: 找 Yes	1	0-1	P87	两段斜率中间模拟量 Two slope intermediate simulation	2700	0-4095
P57	抬压脚电磁铁保护时间 (s) Protecting time of the electromagnet for press foot.	10	1-30	P88	计件数计数单位 unit of counting	1	1-50
P58	上停针调整角度 adjustment angle of up needle position	285	0-359	P89	计件数总数设定 setting of total counting	9999	1-9999
P59	下停针调整角度 adjustment angle of down needle position	165	0-359	P90	计件数模式选择 counter mode 0: 关闭 off 1: 升序循环 计数 Ascending cycle count. 2: 降序循环计数 Descending cycle count. 3: 升序计数, 计满报警 并停止运行 (Ascending accounting to full, alarm and stop running) 4: 降 序计数, 减为 0 报警并停 止运行 (Descending accounting to 0, alarm and stop running) 5: 升 序计数, 计满报警提示, 继续运行 (Ascending accounting to full, remind and keep running) 6: 降 序计数, 减为 0 报警提 示, 继续运行 (Descending accounting to 0, alarm and keep running) 注: 短按 P 取消报警 (note: press P shortly to cancel alarm)	0	0-6
P60	测试速度(r/min) testing speed	2000	200-220 0	P91	预留 reserved	0	0-9999
P61	老化运行时间(s) Aging operation time	3	1-255	P92	预留 reserved	0	0-9999
P62	特殊运行模式 special running mode 0: 正常 normal 1: 简易缝 easy sewing 2: 初始角测 试 initial angle testing 3: 自动测试模式 automatic testing mode	0	0-3	PA3	抬压脚释放放电时间 (press foot lifter release discharge time)	90	0-900
P63	老化停止时间(s) aging stopping time	2	1-255				
P64	保留 reserved	0	0-1	PA4	抬压脚释放 PWM 占空 比(缓放压脚力度) (press foot lifter release PWM duty ratio- lose press foot lifter slowly)	10	0-50

P65	恢复出厂设置 back to the factory setting 0: 无操作 no operation 1:恢复参数为电控出厂参数 back to control box parameter 2:恢复参数为研发出厂参数 Back to R&D parameter	0	0-2	PA6	前加固结束回走一针功能选择开关 (front bartack finished with one stitch back tack selection switch) 0: 关 No 1: 开 Yes	0	0-1
P66	机头保护开关检测 protection switch of machine head testing	1	0-1	PA7	防断针功能选择开关 Safety needle break selection switch 0: 关 No 1: 开 Yes	0	0-1
P67	机头保护开关逻辑 protection switch of machine head	1	0-1	PA8	防断针开始机械角度 Safety needle break starting mechanical angle	20	0-359
P68	最高限速(r/min)Max speed limit	2000	200-250 0	PA9	防断针结束机械角度 Safety needle break finished mechanical angle	90	0-259
P69	预留 reserved	5	0-100	PB0	定针缝中途剪线后加固缝功能选择开关 fixed stitches trimmer in sewing and then bartack selection switch 0: 关 No 1: 开 Yes	0	0-1
P70	踏板抬压脚位置设定 setting of press foot lift position of pedal	800	0-4095	PB1	起缝压脚微抬功能选择开关 starting sewing presser foot lifter move-up selection switch 0: 关 No 1: 开 Yes	0	0-1
P71	起缝延迟时间 delay time of start sewing	260	0-900	PB2	起缝压脚微抬开始角度 starting sewing presser foot lifter move-up start angle	80	0-359
P72	踏板前踩运行开始位置 (相对于回中位置) starting position of pressing the pedal forward	400	0-4095	PB3	起缝压脚微抬结束角度 starting sewing presser foot lifter move-up finished angle	200	0-359
P73	踏板低速运行结束位置 (相对于回中位置)end position at low speed	800	0-4095	PB4	起缝抬压脚开持续时间限制(ms) time limitation for starting sewing presser foot lifter open( ms)	60	0-1000
P74	踏板模拟量最大值 Max value of pedal analog	4000	0-4095				

### 3.6.3 监控参数表(开机后按 P 键+抬压脚键进入) Monitoring parameter list (press P + press foot lifter key to enter)

参数编号 number	参数描述 description	参数编号 number	参数描述 description
M10	针数计数值 stitches account number	M23	初始角度 Initial angle
M11	件数计数值 pieces account number	M24	机械角度 Mechanical angle
M13	操作面板软件版本号 panel version number	M25	踏板前踩模拟量最大值 Max value for pedal forward press
M18	控制器主板软件版本号 main board version number for control box	M26	踏板回中模拟量采样值 Sample value for pedal back
M20	母线电压 Generatrix Voltage	M28	踏板剪线模拟量采样值 Sample pedal value of trimming
M21	机头速度 Machine speed	M30-M37	历史故障代码 Historical Error number

## 4 错误代码 Error code

### 4.1 故障代码表 Error code list

若系统出现报错或报警，请首先检查如下项：1 先确认机器的连接线是否连接完好；2 确认电控和机头是否匹配；3 确认恢复出厂是否准确。

if have Error or alarm, please check first as follows:1. Check the connection wire is connected or not; 2. Check the machine head is matched with the control box; 3. check reset is accurate or not.

故障代码 Error number	代码含义 Code meaning	解决措施 Solutions
Err-01	硬件过流 hardware over-current	关闭系统电源，30 秒后重新接通电源，控制器若仍不能正常工作，请更换控制器并通知厂方。Switch off the power, after 30 seconds, switch on the power, if control box still cannot work, please change the control box and inform the supplier.
Err-02	软件过流 software over-current	
Err-03	系统欠压 system under voltage	断开控制器电源，检查输入电源电压是否偏低（低于 154V）。若电源电压偏低，请在电压恢复正常后重新启动控制器。若电压恢复正常后，启动控制器仍不能正常工作，请更换控制器并通知厂方。Cut off the power of control box, check input power, the voltage is lower than 154V or not. If it is lower, please recover the voltage, then restart the control box. if the voltage is normal, but control box still cannot work, please change the control box and inform the supplier.

Err-04	停机时过压 Over-voltage when stop the machine	断开控制器电源，检查输入电源电压是否偏高（高于 264V）。若电源电压偏高，请在电压恢复正常后重新启动控制器。若电压恢复正常后，启动控制器仍不能正常工作，请更换控制器并通知厂方。Cut off the power of control box, check input power, the voltage is higher than 264V or not. If it is higher, please recover the voltage, then restart the control box. if the voltage is normal, but control box still cannot work, please change the control box and inform the supplier.
Err-05	运行时过压 Over-voltage when machine operation	
Err-06	电磁铁回路 故障 Fault of electromagnet circuit	关闭系统电源，检查电磁铁连线是否正确，是否有松动、破损等现象。若有则及时更换。确认无误后重启系统，若仍不能工作，请更换控制器并通知厂方。Switch off the power, check the electromagnet connect well or not, loose or not, broken or not. If have , please change it in time. If no problem, restart the machine, if control box still cannot work, please change the control box and inform the supplier.
Err-07	电流检测回 路故障 current testing fault	关闭系统电源，30 秒后重新接通电源观察是否能正常工作。重试几次，若该故障频繁出现，请更换控制器并通知厂方。Switch off the power, after 30 seconds, connect power to check it is ok or not, try more times, restart the machine, if control box still cannot work, please change the control box and inform the supplier.
Err-08	电机 堵转 motor locked-rotor	断开控制器电源，检查电机电源输入插头是否脱落、松动、破损，是否有异物缠绕在机头上。排除后重启系统仍不能正常工作，请更换控制器并通知厂方。Cut off the power, check the motor port is loose or not, if tie to machine head or not. After restart the machine, if control box still cannot work, please change the control box and inform the supplier.
Err-09	制动回路故 障 brake circuit fault	关闭系统电源，检查电源板上白色的制动电阻接头是否松动或脱落，将其插紧后重启系统。若仍不能正常工作，请更换控制器并通知厂方。Turn off the power, check the connection of resistance on the power supply restart the machine is loose or not, put it tightly, if control box still cannot work, please change the control box and inform the supplier.
Err-11	面线检测故 障 Surface threads testing fault	检查面线是否断线、底线是否已使用完。重新接上面线或更换底线。若仍不能正常工作。关机重启，重启后若仍不能正常工作，请更换控制器并通知厂方。Check the surface threads and bottom threads is broken or not, connect them. restart the machine, if still cannot work, please change the control box and inform the supplier.
Err-12	电机初始角 度检测故障 Initial angle testing fault	请断电后再尝试 2-3 次，若仍报故障，请更换控制器并通知厂方。Turn off the power, try 2-3 times, if still have Error, please change control box and inform supplier.
Err-13	电机光编码 器信号丢失 故障 In-coder sensor lost	关闭系统电源，检查电机传感器接头是否松动或脱落，将其恢复正常后重启系统。若仍不能正常工作，请更换控制器并通知厂方。Turn off the power, check the motor sensor port is loose or not, restart the machine, if control box still cannot work, please change the control box and inform the supplier.

Err-14	主板读写 EEPROM 故障 EEPROM fault of main board	关闭系统电源，30 秒后重启系统，若仍不能正常工作，请更换控制器并通知厂方。Switch off the power, restart the machine, if control box still cannot work, please change the control box and inform the supplier.
Err-15	电机超速保护 Over-speed protection	
Err-16	电机反转 motor reversal	
Err-18	电机过载 motor overload	

## 4.2 安全报警表 Safety alarm meter

报警代码 Alarm code	代码含义 Description	解决措施 Solutions
A-UP	翻抬开关报警 alarm of safety switch	摆正机头,确保翻抬开关复原 return machine head to normal position, to make sure safety switch rebound

## 5 脚踏板灵敏度调整 Pedal sensitivity adjustment

1) 脚踏板动作由初始位置①（75 号参数）开始，缓慢向前踩至②（72+75 号参数）开始低速缝纫，继续前踩至③（75+73 号参数）开始加速，再深踩至④（74 号参数）达到最高速度。②③段之间维持起缝速度，③④段之间为无级调速过程；

1) pedal action from the initial position (1), (parameters 75), slowly stepped forward to (2) (72 + 75 parameter) ,and began to work at low-speed, continuing press to position(3) (75 + 73 parameter), then began to accelerate, deep step to position (4) (parameters 74) to achieve the highest speed. The speed of stitching between position ② and ③ is to maintain the starting sewing speed. The speed of stitching between position ③ and ④ is to increase the speed.

2) 当脚踏板由初始位置①（75 号参数）开始，缓慢后踩至⑥（24 号参数）时自动完成回到上停针动作；

2) when the pedal is started from the initial position (1) (parameter 75), the pedal will automatically return to the un needle position when it is slow to step on the (6)(24 parameter).

3) 各参数数值设置需保证（24 号参数）<（75 号参数）<（75+72 号参数）<（75+73 号参数）<（74 号参数）；

3) the value setting of each parameter should be guaranteed (24 parameter) < (75 parameter) < (75+72 parameter) < (75+73 parameter) < (parameter 74);

4) 可通过监控模式下 025、026、028 号参数实时监测踏板模拟量最大值、踏板回中电压采样值、踏板倒踩电压采样值，操作方式同上停针位置设置方式，不同位置下的踏板采样数值作为各参数的参

考值。如前踩很大距离机器还没有运转，可适当减小 72 参数（72+75 号参数应大于回中位置参数 75），即可提高前踩的灵敏度；若机器过于灵敏，轻触踏板机器就开始运行，可适当加大 72 参数；若不容易补针，稍微前踩，速度就迅速提高造成前冲多针，可适当增大 73 参数或减小 72 参数（即增大脚踏板低速范围），也可以适当降低初始起缝速度（00 号参数）。

4) Under monitoring mode, parameters 025、026、028 can monitor the real-time pedal analog voltage sampling value in maximum, pedal back, pedal down step voltage sampling values. The setting is the same as above-mentioned needle position setting mode. Under different positions of the pedal, sampling values is for reference. If the machine has not been running after stepping forward, we can reduce parameter 72 properly (the parameters of 72+75 should be larger than 75), so as to improve the sensitivity of the front tread. If the machine is too sensitive, touch pedal lightly, machine will start running, you can increase parameters 72 appropriately. If it is not easy to add stitch, stepping forward little, speed will quickly improve to blunt stitches, can increase parameters 73 or reduce parameters 72 properly (i.e., increase low-speed range of the pedals), can also decrease initial starting speed (parameters 00)

