

SEWING MACHINE TABLE
COMFORT 1 (C 1L , C 1XL)
СТОЛ ДЛЯ ШВЕЙНОЙ МАШИНЫ



SYMBOLS



ATTENTION

ВНИМАНИЕ



ASSEMBLY & ADJUSTMENT

СБОРКА РЕГУЛИРОВКА



OPERATION

ЭКСПЛУАТАЦИЯ



STORAGE

ХРАНЕНИЕ

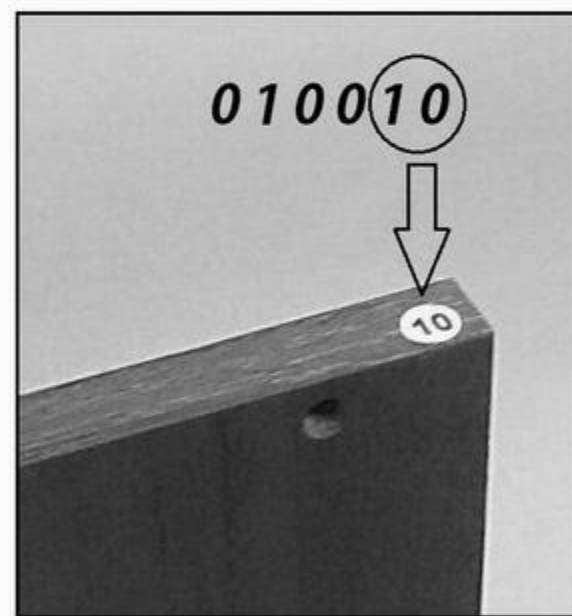

INDICATING MARK

ОБОЗНАЧЕНИЕ

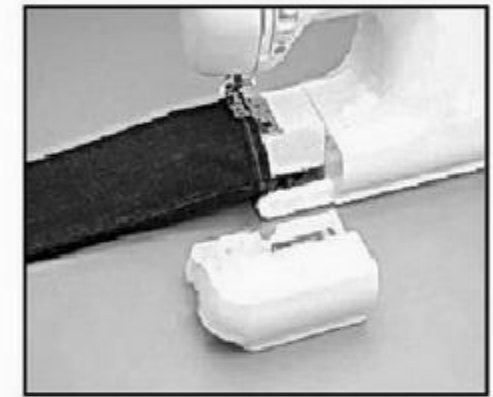

SPECIAL OPERATION

СПЕЦИАЛЬНЫЕ ОПЕРАЦИИ

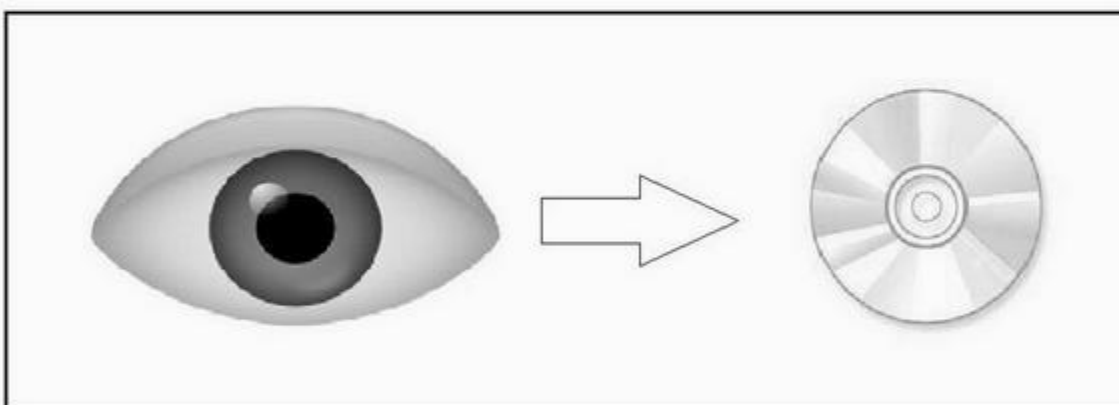

WATCH DVD

СМОТРЕТЬ DVD

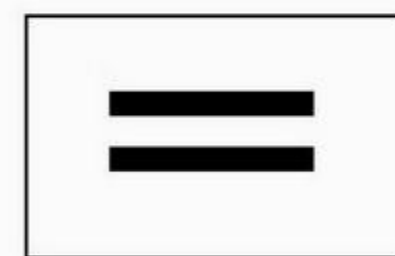

EQUALITY



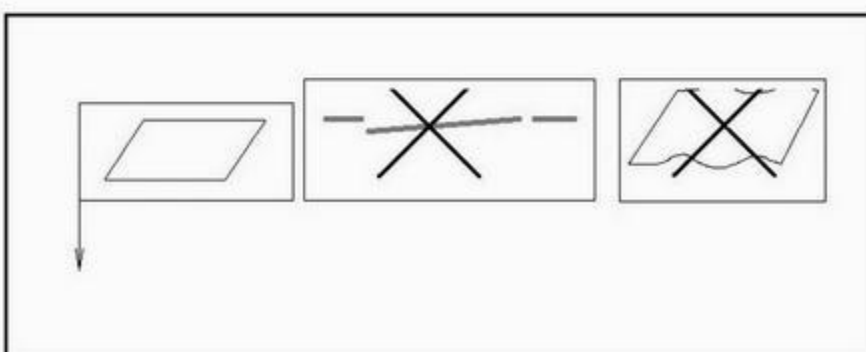

РАВЕНСТВО









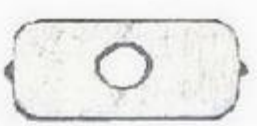

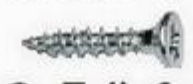

EVEN SURFACE

РОВНАЯ ПОВЕРХНОСТЬ

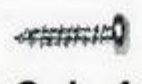
010001 1x 010002 1x 010003 1x 010004 1x
 010006 1x 010007 1x 010008 1x 010009 1x

 020001 2x	 020002 2x	 020003 1x	 020004 1x	 020005 1x
---	---	--	--	--

 020006 1x	 020008 1x	 020010 L 660 1x	 020011 1x	 020012 1x
--	--	---	--	--

 030001 3 * 16 23x	 030002 3,5 * 16 8x	 030003 6,2 * 50 8x	 030004 φ5 * 30 4x	 030005 4,2 * 16 25x	 030006 2,9 * 13 4x
 030007 φ6 2x	 030008 φ4 2x	 030009 M4 * 20 2x	 030010 φ6 4x	 030011 φ15 8x	 030012 φ18 6x

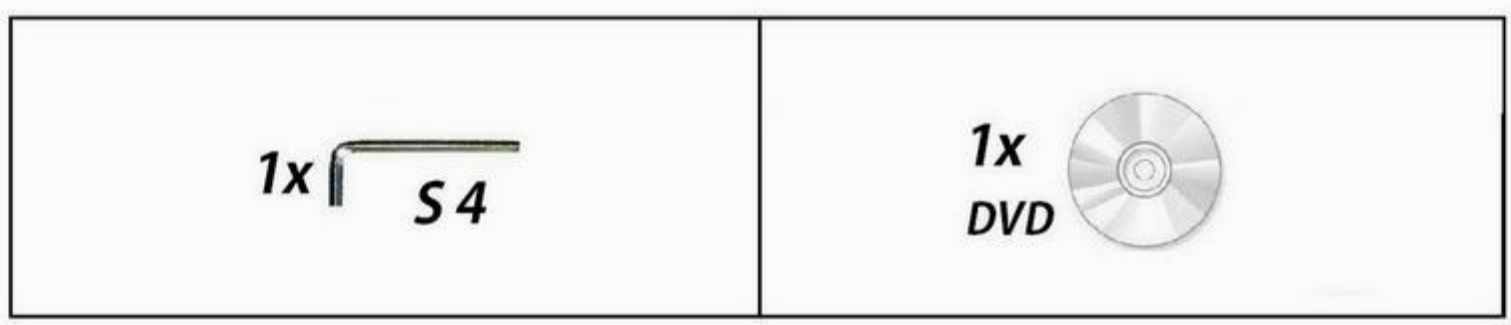
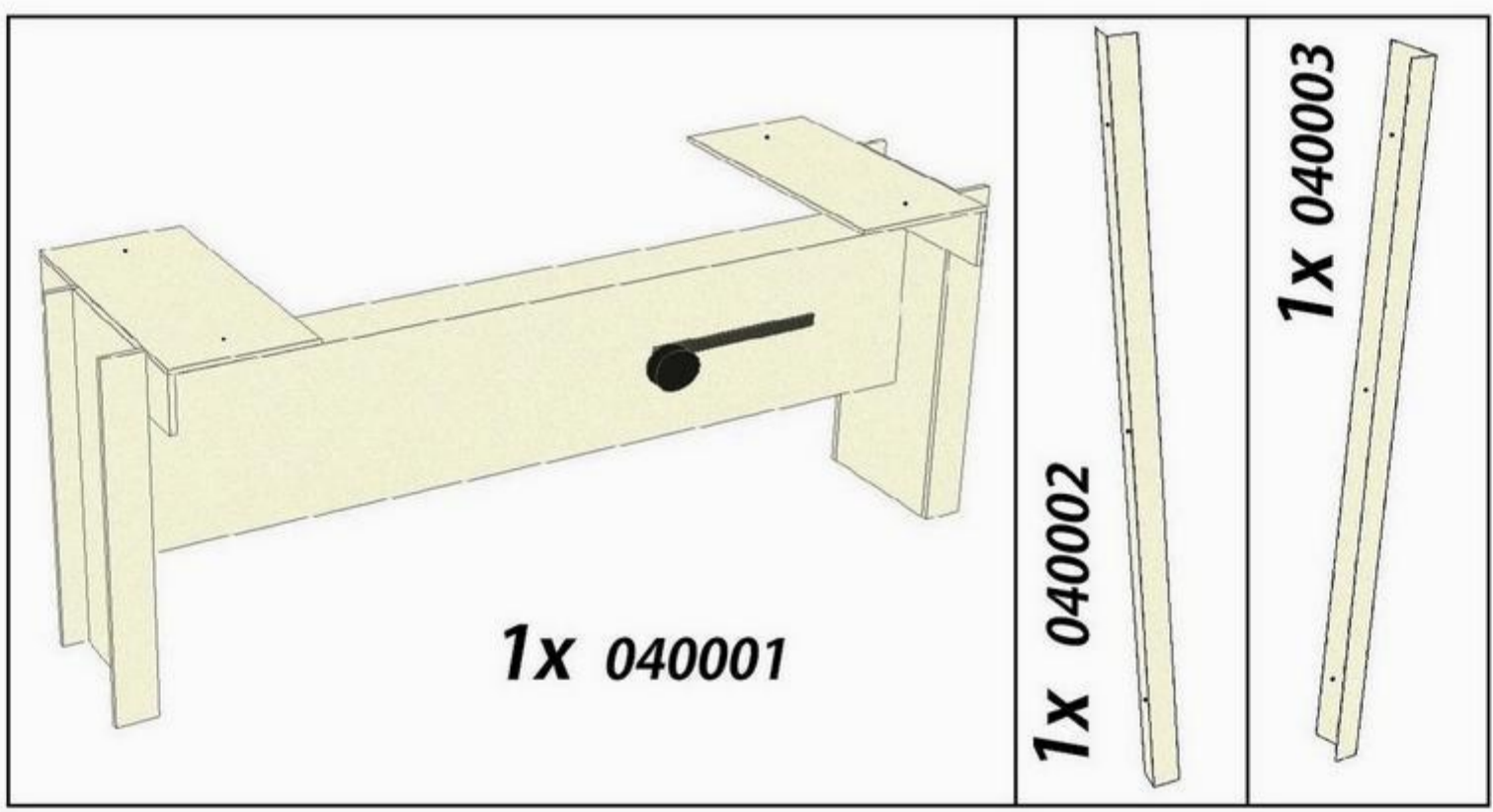

 030013 L = 35 6x	 030015 φ8 * 30 6x	 030014 φ15 h12 6x
--	---	---





S 4 S 10





1 8 x  030011
030003
8 x 

010003

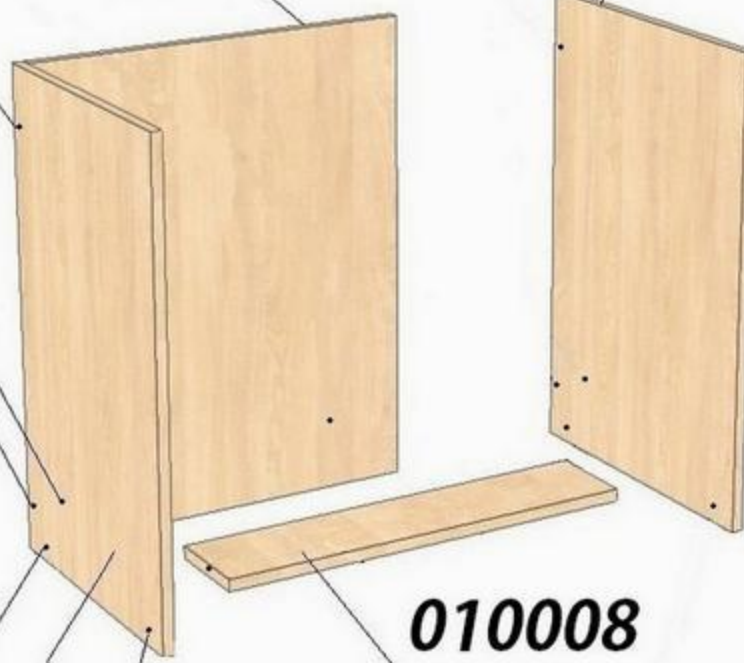
010006



010008

2 020001
2 x 
2 x 
2 x  030004

010004

3 020002
2 x 
2 x 
2 x  030004

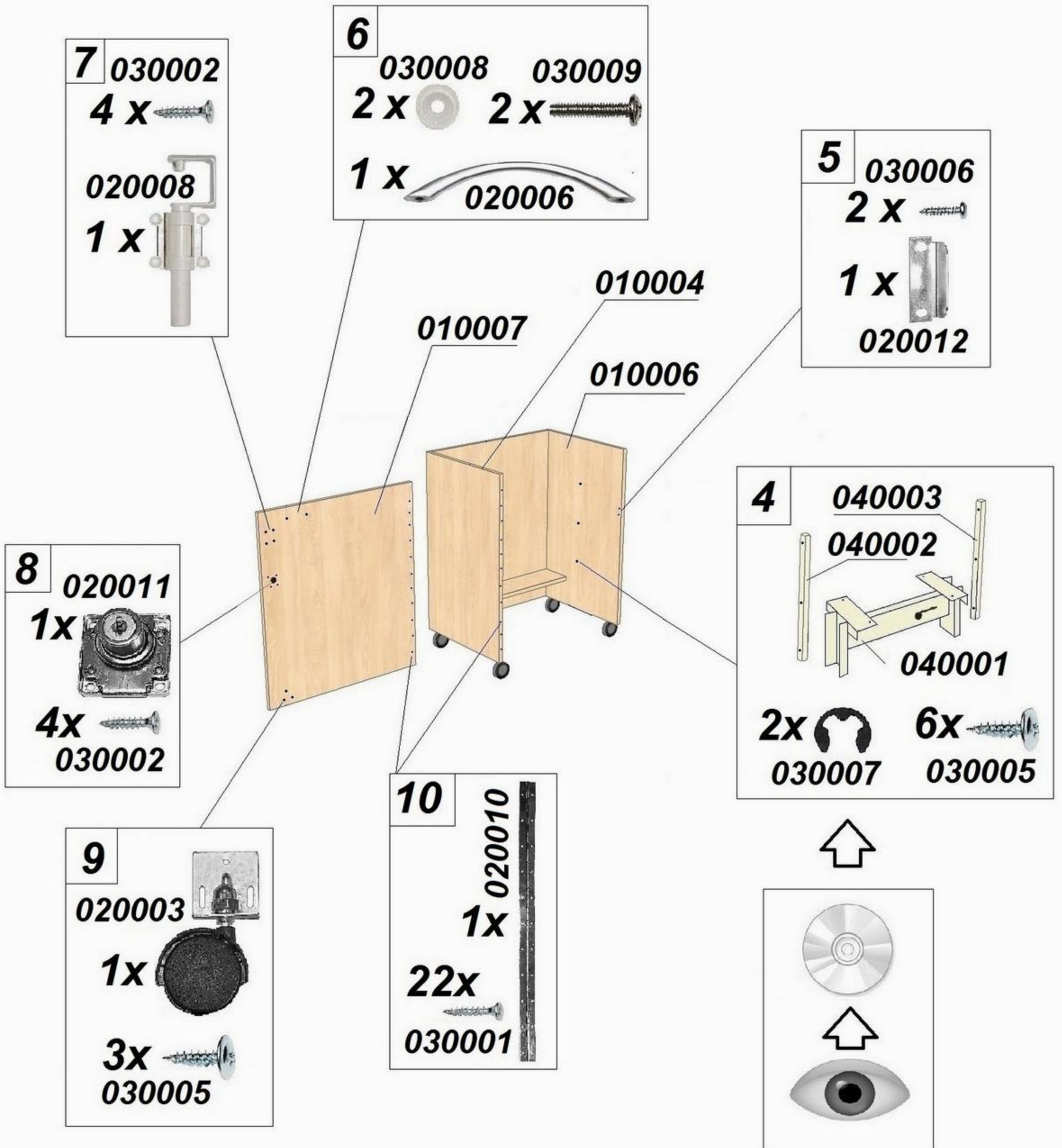

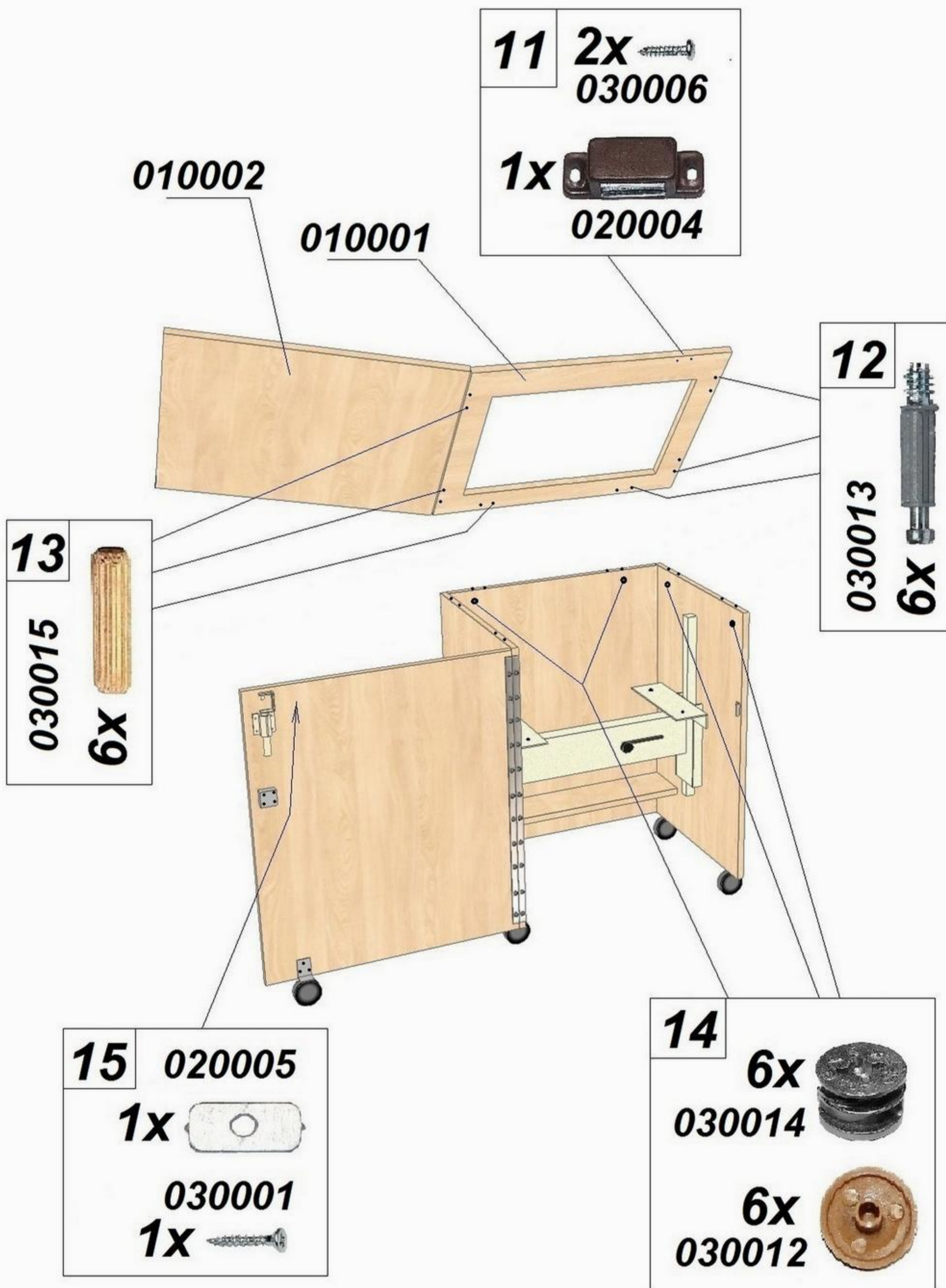

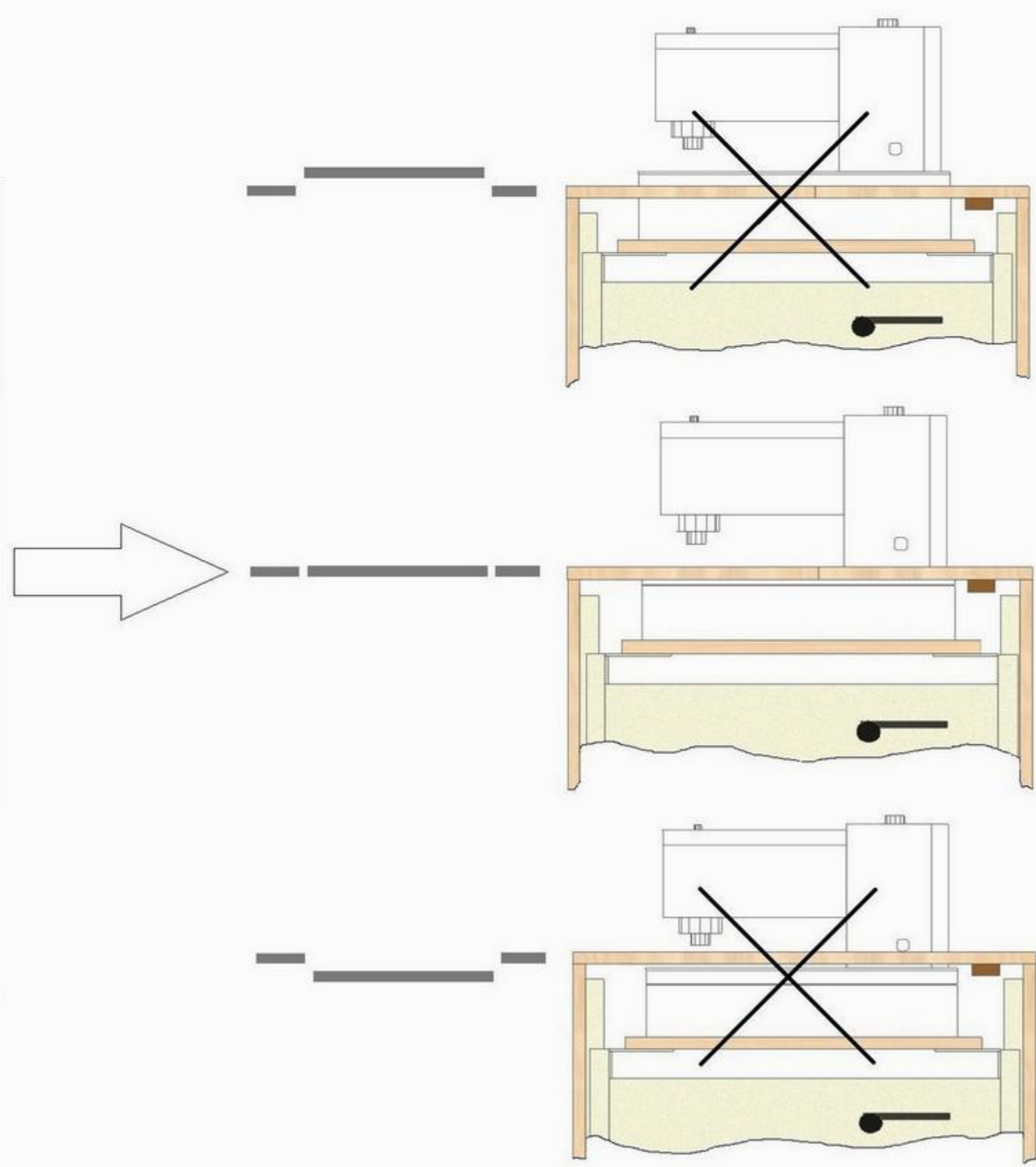
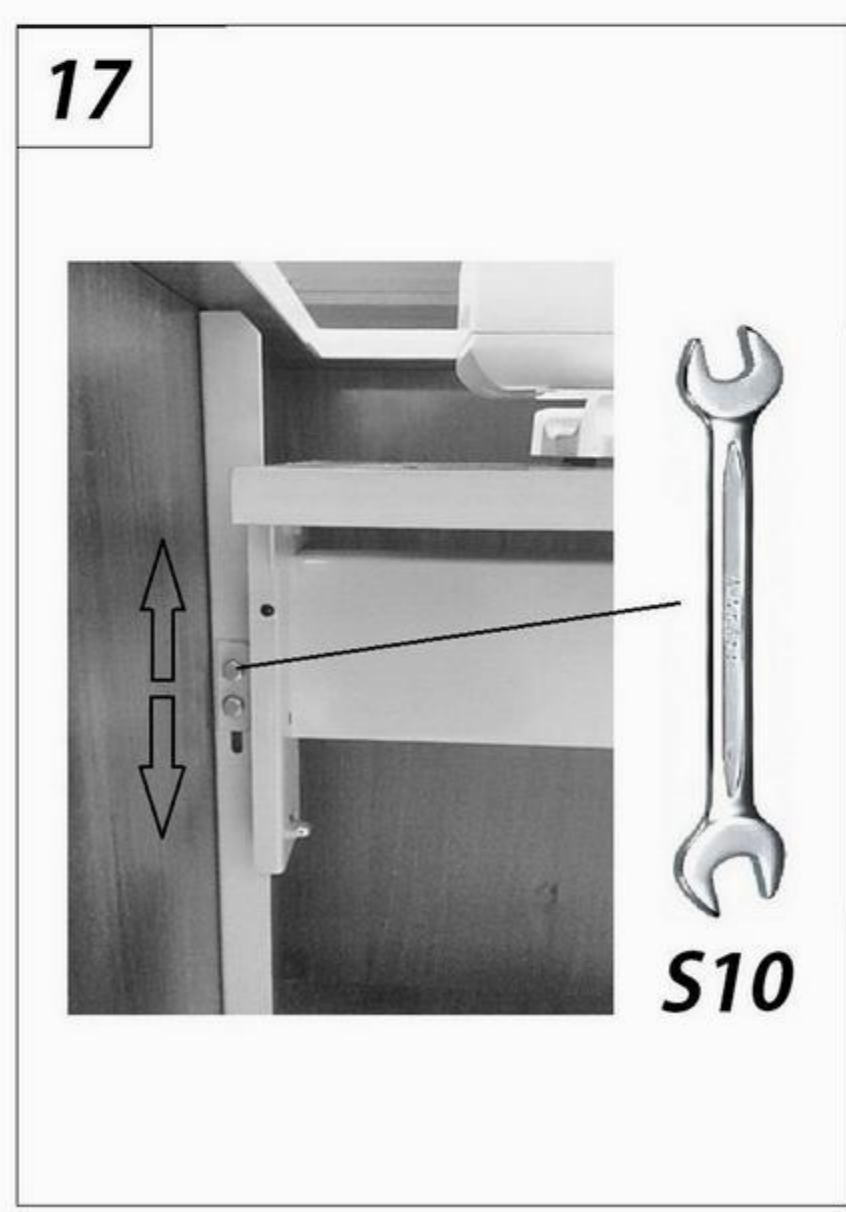
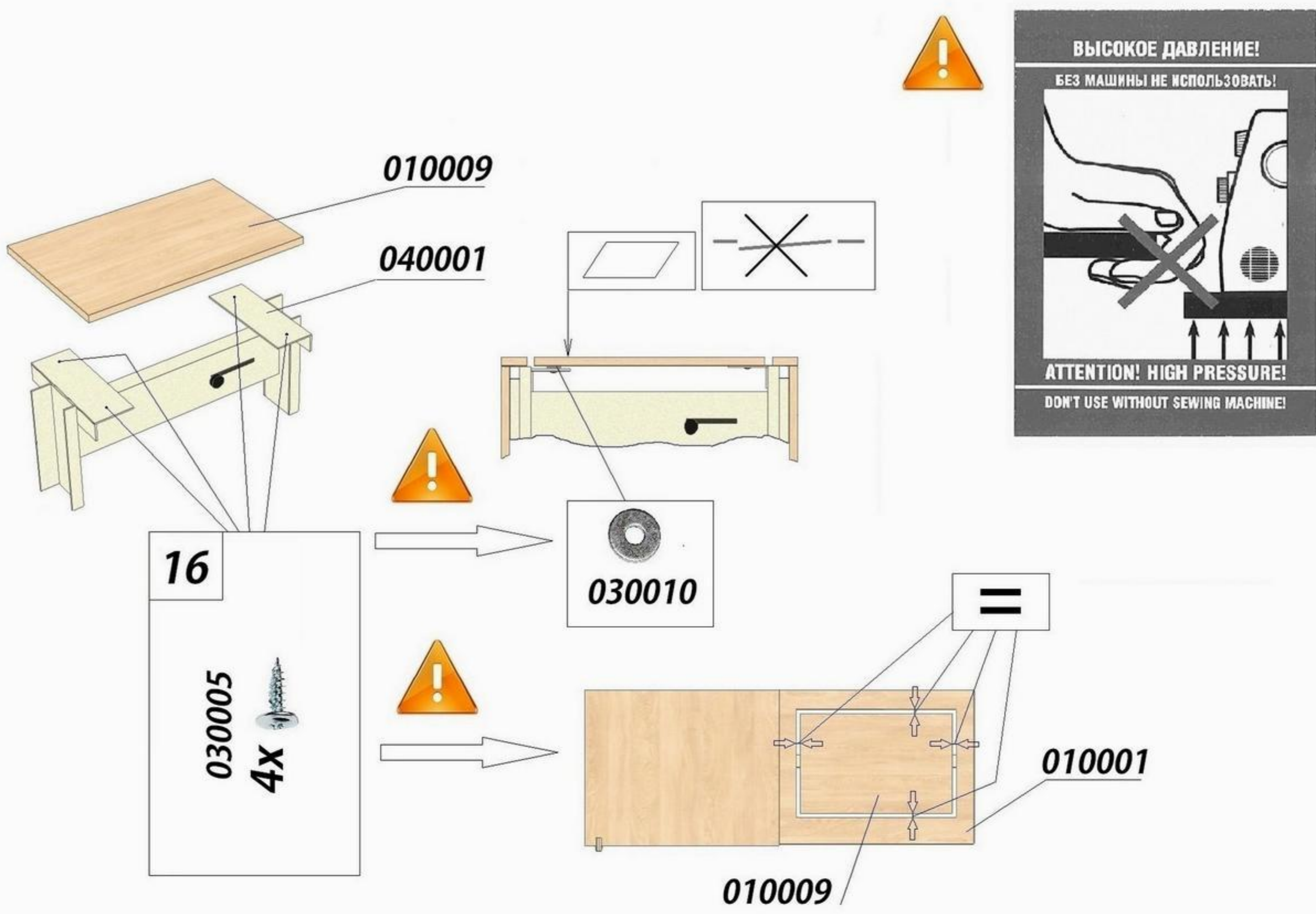

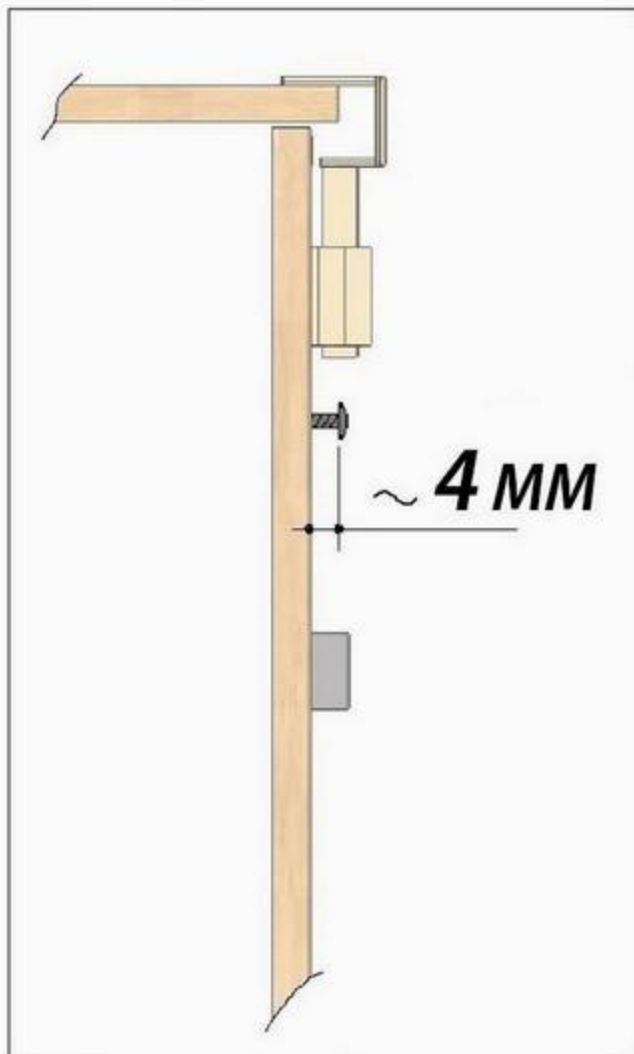

030005

